

Technical data sheet

Actuator sensor interface · USB Panel pass through devices

USB 3.0 panel connector with M22 thread for front installation
USB connector Type A on straight USB plug Type A with PVC cable

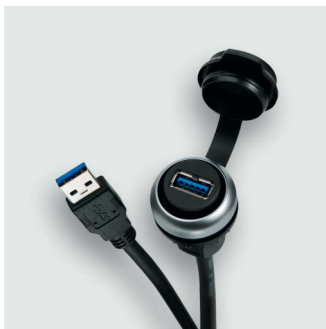

Identification

Type USB-3.0 A/A F/M 5,0m PVC
Part No. [490113.0500](#)

Product version

Datasheet version 00

General

Design	USB-A
Form male 1	USB 3.0 female Type A
Form male 2	USB 3.0 male Type A
Degree of pollution	3
Contact resistance	<30 mΩ
Degree of protection	IP65 UL50E Type 2, 3R, 4, 4X, 12, 13 in closed and IP20 in inserted position
Housing material	PA, PVC
Cover	TPU
Contact material	CuSn, gold-plated
Mounting	Front installation
Installation depth	approx.70 mm
Number of conductors/cross-section	(2×AWG24 + 1×2×AWG28 + 2×(1×2×AWG28)St)StC
Jacket material	PVC
Jacket color	black
Cable diameter	6.1 mm
Bending radius	6×cable OD
Operation temperature range	-5 °C ... +70 °C
Temperature range fixed	-25 °C ... +80 °C
Temperature range moving	-5 °C ... +70 °C
Dimensions (Ø×d)	29.5 × 45 mm
Mechanical service life	1500 insertion cycles
Weight/unit	0.24 kg
PU (units)	1

USA: LUTZE INC.

13330 South Ridge Drive • Charlotte, NC 28273, USA
Tel. +1 (704) 504-0222 • Fax +1 (704) 504-0223
www.lutze.com • info@lutze.com

26.07.2023 • Subject to technical modification
Part No. [490113.0500](#) • Datasheet version: 00

Technical data sheet

Actuator sensor interface · USB Panel pass through devices

Technical data

Rated voltage U_N	AC/DC 5 V
Operating voltage max.	30 V
Rated current	0.9 A
Pole number	9
Cable length	5 m
Transfer rate	5 Gbit/s
USB standard	3.0
Contact type	1 : 1
Shielding	shielded

Approvals/Standards

Approvals	cULus Listed (E326112)
-----------	------------------------

Equipment/Spare parts

Accessories	Included in the delivery: attached safety cap
-------------	--

Dimensions

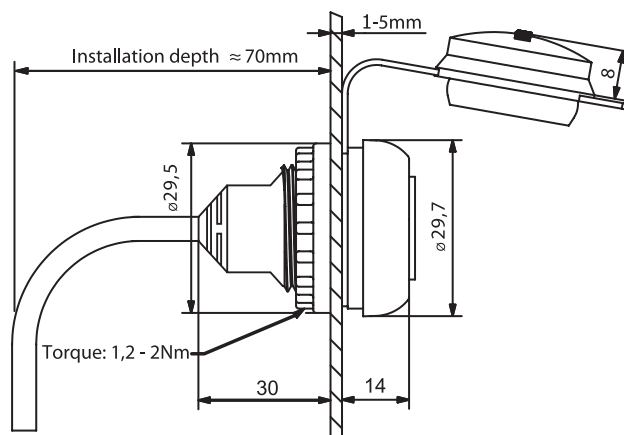

Technical data sheet

Actuator sensor interface · USB Panel pass through devices

PIN assignment

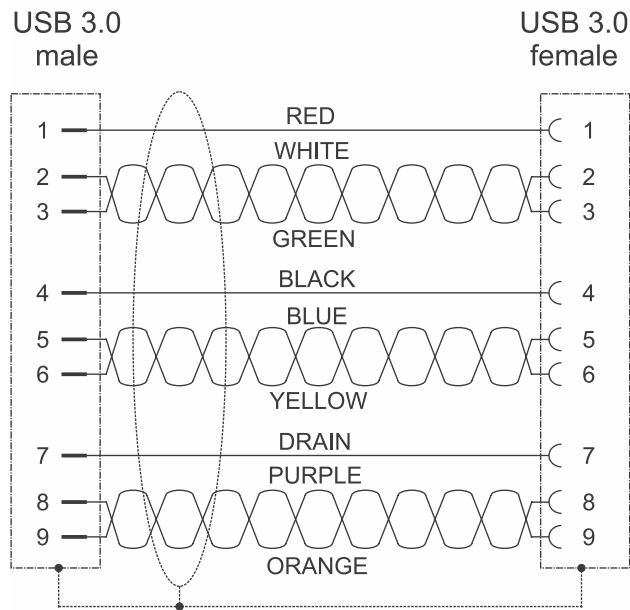

Front view

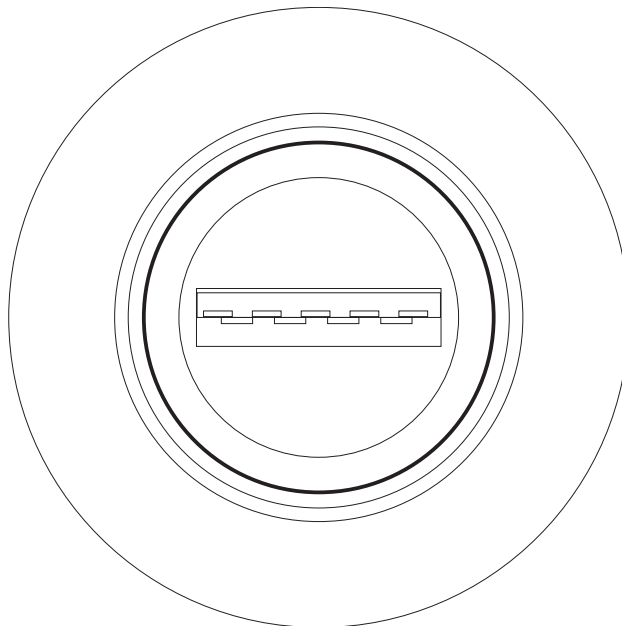

Technical data sheet

Actuator sensor interface · USB Panel pass through devices

Mounting diagram

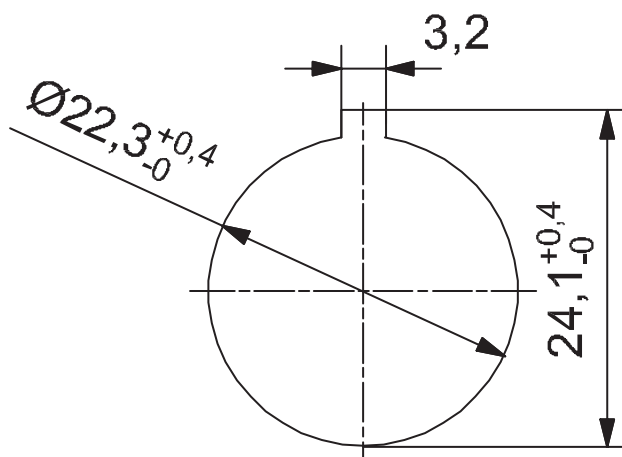

Pin layout

